

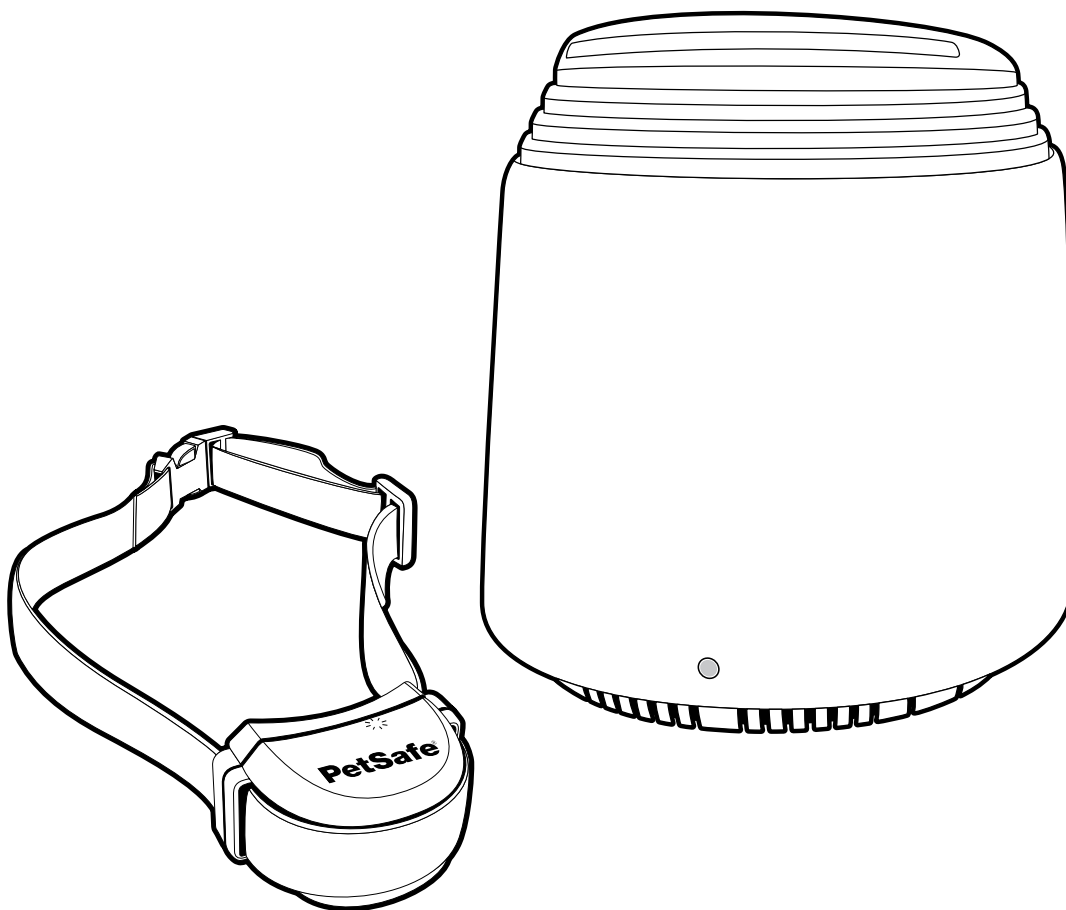

PIF00-12917

## Stay & Play™ Compact Wireless Fence



Please read this entire manual before beginning

# Welcome

You and your pet were made for each other. Our aim is to help you have the best companionship and the most memorable moments together. Your new Stay & Play™ Compact Wireless Fence is designed to give your pet maximum freedom while keeping him safe.

We know that safe pets make happy owners. Before getting started, please have your utilities marked, and take a moment to read through the important safety information. If you have any questions, please don't hesitate to contact us.

Hereinafter Radio Systems Corporation, Radio Systems PetSafe Europe Ltd., Radio Systems Australia Pty Ltd. and any other affiliate or Brand of Radio Systems Corporation may be referred to collectively as "We" or "Us".

## Important Safety Information

Explanation of Attention Words and Symbols used in this guide



This is the safety alert symbol. It is used to alert you to potential personal injury hazards. Obey all safety messages that follow this symbol to avoid possible injury or death.

### **WARNING**

**WARNING** indicates a hazardous situation which, if not avoided, could result in death or serious injury.

### **CAUTION**

**CAUTION**, used with the safety alert symbol, indicates a hazardous situation which, if not avoided, could result in minor or moderate injury.

### **CAUTION**

**CAUTION**, used without the safety alert symbol, indicates a hazardous situation which, if not avoided, could result in harm to your pet.

### **NOTICE**

**NOTICE** is used to address practices not related to personal injury.

### **WARNING**

- Not for use with aggressive pets. Do not use this product if your pet is prone to aggressive behavior. Aggressive pets can cause severe injury or death to their owners and others. If you are not sure that this product is right for your pet, please talk to your veterinarian or a certified trainer.
- Risk of electric shock. Use the fence transmitter indoors in a dry location only.
- The battery should be charged in areas with temperatures ranging from 32°F to 104°F / 0°C to 40°C. Recharging the battery outside of this temperature range can cause the battery to overheat, explode or catch fire.
- This device contains Lithium-Ion (Li-Ion) batteries; never incinerate, puncture, deform, short-circuit, or charge with an inappropriate charger. Fire, explosion, property damage, or bodily harm may occur if this warning is not followed.

### **CAUTION**

- This system is NOT a solid barrier. It is designed to act as a deterrent to remind pets to remain within the established boundary by use of static correction. It is important that you reinforce training with your pet on a regular basis. Since the tolerance level to static correction varies from pet to pet, Radio Systems Corporation CANNOT guarantee that the system will, in all cases, keep a pet within the established boundary. Not all pets can be trained to avoid crossing the boundary! Therefore, if you have reason to believe that your pet may pose a danger to others or harm himself if he is not kept from crossing the boundary, you should NOT rely solely upon this system to confine your pet. Radio Systems Corporation shall NOT be liable for any property damage, economic loss or any consequential damages sustained as a result of any animal crossing the boundary.
- This product is not a toy. Keep it out of the reach of children.

**CAUTION**

Proper fit of the receiver collar is important. A receiver collar worn for too long or made too tight on your pet's neck may cause skin damage, ranging from redness to pressure ulcers. This condition is commonly known as bed sores.

- **Avoid leaving the receiver collar on your pet for more than 12 hours per day.**
- When possible reposition the collar on your pet's neck every 1 to 2 hours.
- Check the fit to prevent excessive pressure; follow the instructions in this product manual.
- Regularly recheck the fit to prevent excessive pressure; follow the instructions in this product manual.
- You may need to trim the hair in the area of the contact points. Never shave your pet's neck; this may lead to a rash or infection.
- Never connect a leash to a collar with contact points. It will cause excessive pressure on the contact points.
- When using a separate collar for a leash, do not put pressure on the receiver collar.
- Wash your pet's neck area and the contact points of the receiver collar weekly with a damp cloth.
- Examine the contact area daily for signs of a rash or a sore.
- If a rash or sore is found, discontinue use of the receiver collar until the skin has healed.
- If the condition persists beyond 48 hours, see your veterinarian.
- For additional information on bed sores and pressure necrosis, please visit our website.
- Proper training of your pet is essential to successfully using the system. During the first 2 weeks of training, do not use the system without direct supervision of your pet.
- The boundary zone must be tested whenever an adjustment is made to the transmitter setting to prevent unintended corrections to your pet.
- Always remove your pet's receiver collar before performing any fence transmitter testing. This will prevent unintended corrections.
- To prevent an unintended correction, after the boundary flags have been placed, be sure to set the static correction on the receiver collar back to level 1, which is tone only.
- To prevent an unintended correction, remove the receiver collar from your pet when indoors.
- Never remove power from the system when the collar is on the pet. This may activate the receiver collar.
- Radio Systems Corporation recommends the use of an Uninterruptible Power Supply (UPS) for use with your wireless fence. Should the power go out at your home, your pet will be unprotected. Power outages can be unpredictable, and the use of a UPS will provide you with some time to properly restrain your pet.

In rare instances, if your pet is near the boundary at the time when the power fails, it is possible that your pet will receive a correction. This correction will stop after a 15 second timeout period has been reached. This is due to the operation of the collar: the collar is activated by the absence of the containment signal.

While results will vary depending on the UPS manufacturer's specifications the following are typical examples to guide your choice of UPS:

- Using a 400 VA UPS a consumer should expect 3 hours of backup time.
- Using a 900 VA UPS a consumer could expect 8 hours of backup time.

**NOTICE**

- You should expect hundreds of recharge cycles from your battery; however, do not charge your receiver collar every night. Charging too often can reduce battery life.
- Charge your receiver collar when the receiver indicator light blinks yellow; or when the light blinks red.
- Do not place anything on the top of the transmitter or cover any ventilation holes. This may overheat the transmitter and cause early transmit failure.
- Do not place transmitter in a closet or any other confined, unventilated area.
- Do not place transmitter on or near a metal surface.

# What's Covered

Components.....	5
Other Items You May Need.....	5
How the System Works.....	6
Key Definitions.....	6
<b>Operating Guide</b> .....	7
Step 1: Set Up the Transmitter.....	7
Step 2: Charge the Receiver Collar.....	8
Step 3: Prepare the Receiver Collar.....	9
Step 4: Adjust the Pet Area to Desired Size.....	12
Step 5: Place the Boundary Flags.....	14
Step 6: Fit the Receiver Collar.....	14
Training.....	16
Day 1.....	16
Days 2–4.....	16
Days 5–8.....	17
Days 9–30.....	17
Taking Your Pet Out of the Pet Area.....	17
Wireless-to-Go.....	18
<b>Troubleshooting</b> .....	18
Terms of Use and Limitation of Liability.....	21
Compliance.....	22
Customer Care International.....	22
Important Recycling Advice.....	22
Warranty.....	22
Mounting Template.....	24

# Components

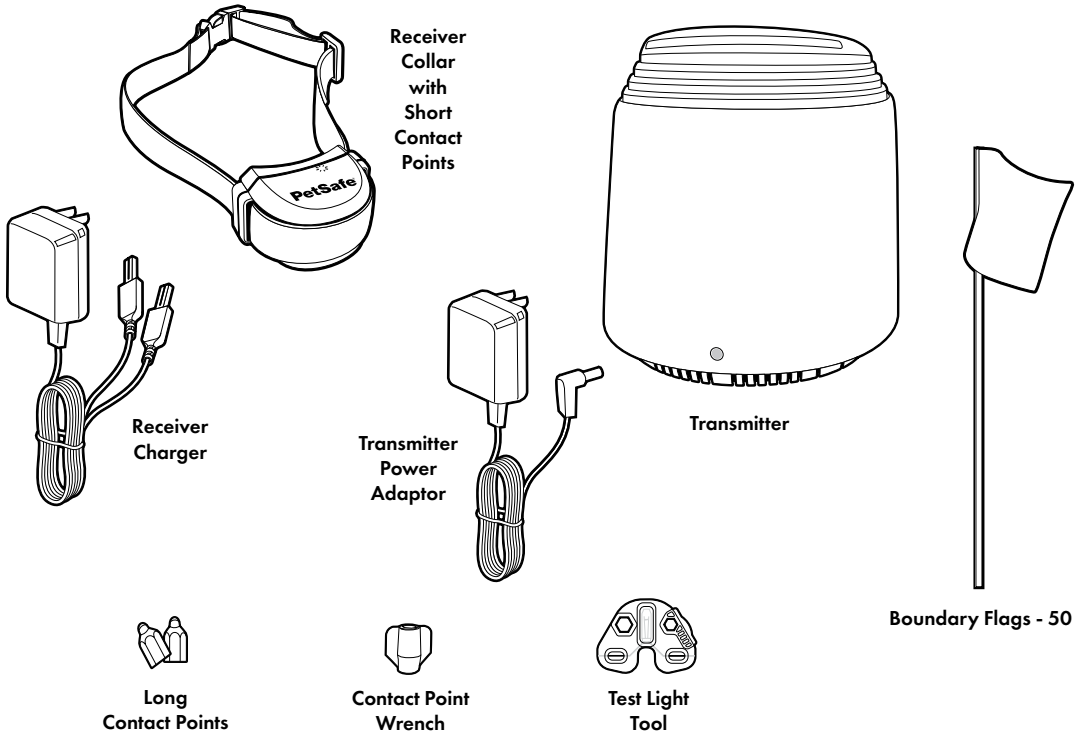

## Other Items You May Need

- Screwdriver
- Scissors
- Lighter
- Drill and mounting hardware
- Tape measure
- Non-metallic collar and leash

For help with setup and training, please visit [petsafe.com](http://petsafe.com).

# How the System Works

The PetSafe® Stay & Play™ Compact Wireless Fence system has been proven safe, comfortable, and effective for pets over 5 pounds. The system works by transmitting a radio signal up to 105 feet in all directions. You temporarily define the pet area with boundary flags for a visual aid in training your pet. Your pet wears a receiver collar with contact points that touch his neck, and, once trained, is allowed to roam freely in the pet area. When your pet reaches the boundary zone, the receiver collar gives a warning tone before delivering a safe static correction through the contact points to get his attention until he returns to the pet area.

## Key Definitions

**Transmitter:** Transmits the radio signal and is the center of the pet area. The transmitter needs to be located indoors.

**Pet Area:** Distance from the transmitter where your pet can roam freely.

**Boundary Zone:** 2- to 3-foot-wide area outside the pet area where your pet's receiver collar will begin to tone and then begin to deliver a static correction. The correction will start in the boundary zone and continue anywhere beyond the pet area.

**Note:** The receiver collar is equipped with a safety time-out feature that will stop correcting after 15 seconds if your pet remains outside the pet area.

**Receiver Collar:** Receives the radio signal from the transmitter.

**Receiver Indicator Light:** Indicates the level of correction at which the receiver collar is set. This light also indicates battery status.

**Contact Points:** Deliver the safe static correction when your pet moves into the boundary zone.

**Mode Button:** Turns receiver on/off and adjusts the level of static correction your pet receives outside the pet area.

**Receiver Charger:** Charges the batteries inside the receiver collar

**Receiver Charge Jack:** Connection point for charging receiver battery.

**Power Light:** Indicates when the transmitter is on.

**Power Jack:** Where the power adaptor plugs into the transmitter. The transmitter is powered by a standard 120 volt outlet.

**Boundary Switch:** Adjust according to the size of the pet area desired.

**Note:** Adjusting the switch does not change the level of static correction on the receiver collar.

**Boundary Control Dial:** Adjusts the distance from the transmitter to the boundary zone.

**Note:** Adjusting the dial does not change the level of static correction on the receiver collar.

**Alarm Disable Button:** Silences power loss alarm and re-initiates the transmitter radio signal after metal interference alarm activates.

**Power Loss Alarm:** Sounds an intermittent single tone alarm which indicates power has been removed from the transmitter.

**Metal Interference Alarm:** Disables the transmitter radio signal to protect the transmitter from damage if placed too close to metal objects.

**Transmission Failure Alarm:** Continuous tone which indicates a transmitter problem.

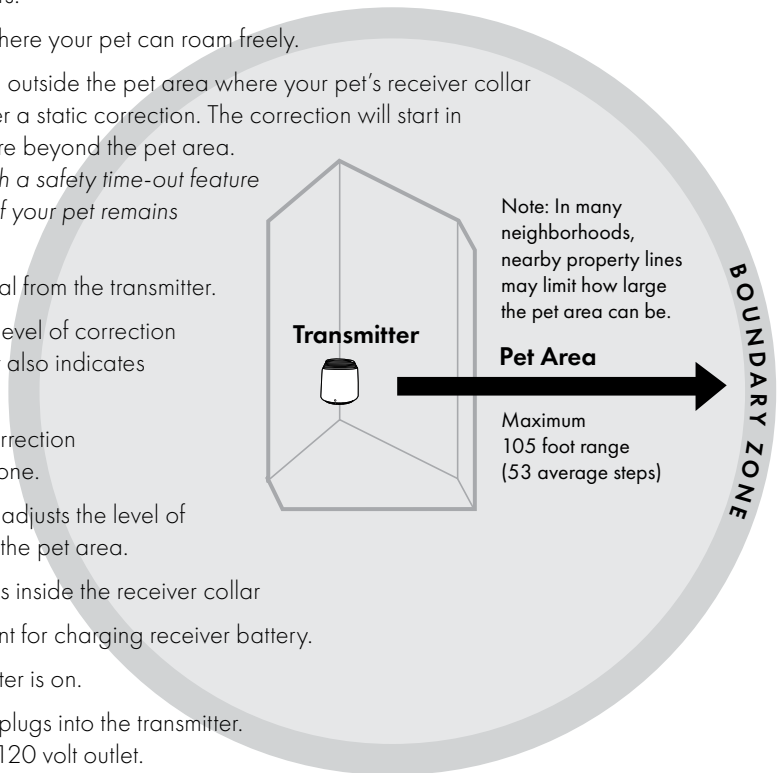

# Operating Guide

## Step 1: Set Up the Transmitter

**Important:** You may need to move the transmitter several times before determining the final location. The transmitter is located at the exact center of the pet area.

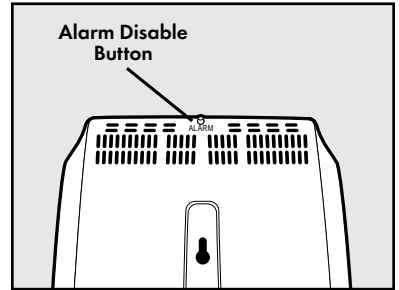
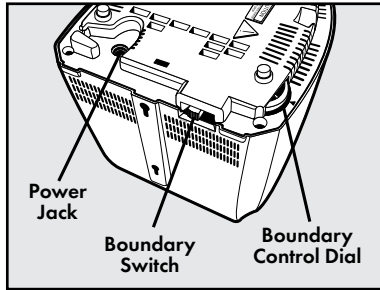
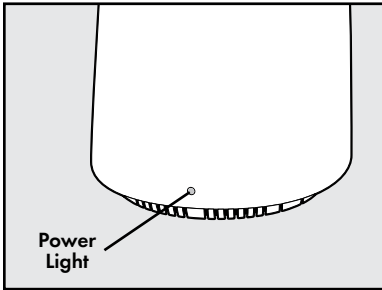

### Place the Transmitter:

- At least 2 feet above the floor located on the ground floor of your home.
  - In a dry, well ventilated, protected area.
  - In an area where temperatures do not fall below -10°F (-23°C) or above 140°F (40°C)
  - On a non-metal table or other hard surface to ensure proper ventilation (**1A**).
  - At least 3 feet from large metal objects, as these items may reduce the size and shape of your pet area (**1B**).
- Placing the transmitter inside a metal building or shed can reduce the maximum range of the Stay & Play™ Compact Wireless Fence system.

### You can also mount on a wall.

A mounting template is included on the back of this manual.

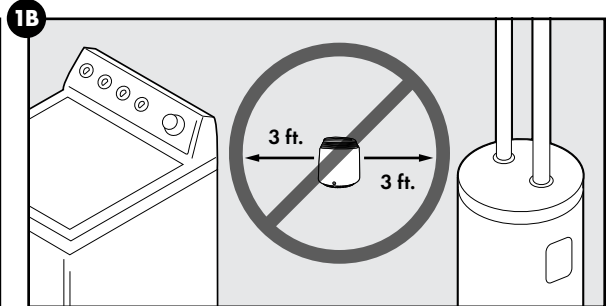
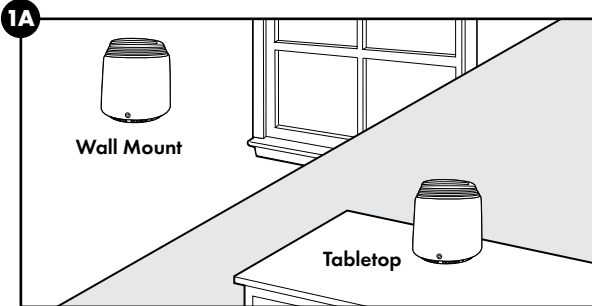

### NOTICE

- Do not place anything on top of transmitter or cover any ventilation holes. This may overheat the transmitter and cause early transmit failure.
- Do not place transmitter in a closet or any other confined, unventilated area.
- Do not place transmitter on or near a metal surface.

## Transmitter Alarms

The transmitter has three built-in warning alarms:

- Power loss alarm
- Metal interference alarm
- Transmission failure alarm

### Power Loss Alarm

The power loss alarm sounds an intermittent single tone alarm indicating power has been removed from the transmitter. The power loss alarm will last up to 30 minutes. In the event of a power loss, your pet is no longer contained.

There are three ways to turn off the power loss alarm.

1. Plug the adaptor into a functional 120 volt outlet.
2. Unplug the transmitter power adaptor from the power jack located on the bottom of the transmitter.
3. Press the alarm disable button for 5 seconds then release. Three short tones will sound to signify the alarm has been turned off.

### Metal Interference Alarm

The metal interference alarm sounds an intermittent double tone alarm indicating that the transmitter has been set towards the maximum range and placed on or close to a metal surface. If the metal interference alarm sounds, your pet is no longer contained. You must relocate the transmitter away from metal or the alarm will continue to sound and the transmission from the transmitter will remain disabled.

There are two ways to turn off the metal interference alarm and re-initiate the transmitter radio signal.

1. Unplug the transmitter power adaptor from the power jack located on the bottom of the transmitter.
2. Press the alarm disable button for 5 seconds then release.

### Transmission Failure Alarm

The transmission failure alarm makes a continuous tone indicating a transmitter problem. In this situation, your pet can no longer be contained. Contact the Customer Care Center for a replacement.

---

## Step 2: Charge the Receiver Collar

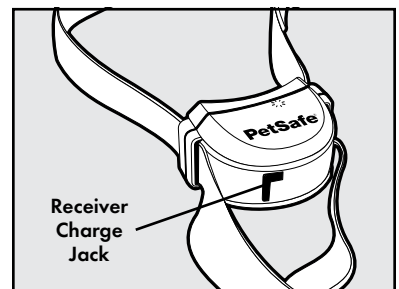
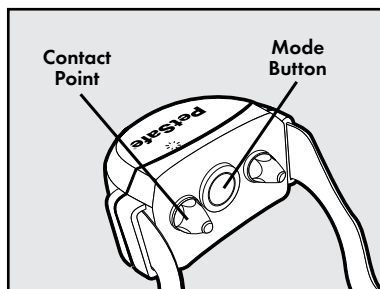
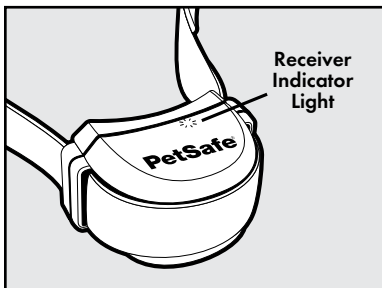

The receiver collar charger is designed to plug into a standard AC wall outlet. The receiver collar light will glow red when the receiver charger is properly seated into the receiver charge jack. The light will turn green when charging is complete. A built-in safety circuit prevents the receiver collar from overcharging.

The receiver collar will achieve a full charge in 2–3 hours. Each charge can last up to 3 weeks depending upon frequency of use.

### **NOTICE**

Do not charge your receiver collar every night. Frequent charging can have a negative effect on the battery. We recommend that the receiver collar be used until the receiver indicator light blinks yellow or red.



## Charge the Receiver Collar

Lift and slide the receiver collar strap away from the front of the unit (**2A**). Lift the rubber plug to allow access to the receiver charge jack. The rubber plug needs to remain attached to the receiver collar. Plug the receiver charger into the receiver charge jack on the receiver collar. The receiver charge jack and receiver charger are keyed to fit one way. Do not force it in backwards.

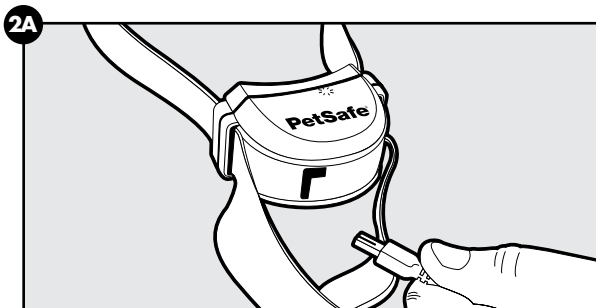

## Step 3: Prepare the Receiver Collar

Your receiver collar comes with short contact points. Use the long contact points for pets with long or thick hair. Tighten the contact points using the contact point wrench (**3A**). Check tightness weekly.

### Turn the Receiver Collar ON

Press and hold the mode button continuously for 5 seconds (**3B**). The green or yellow or red receiver indicator light will turn ON for 5 seconds (**3C**) to indicate battery status, followed by the red receiver indicator light flashing the static correction level settings.

### Turn the Receiver Collar OFF

Press and hold the mode button continuously for 5 seconds. The red receiver indicator light will be ON during this time. The red receiver indicator light will then turn OFF and all receiver indicator lights will stay OFF indicating that the unit is turned OFF.

To extend the time between charging the receiver collar, consider turning OFF the receiver collar when it is not in use.

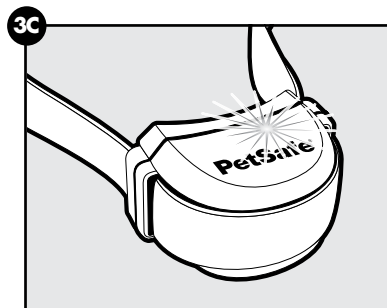
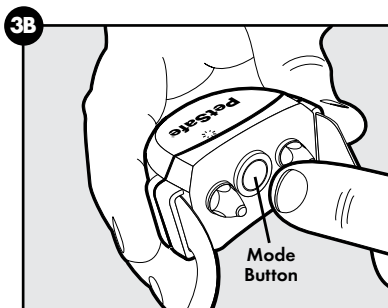
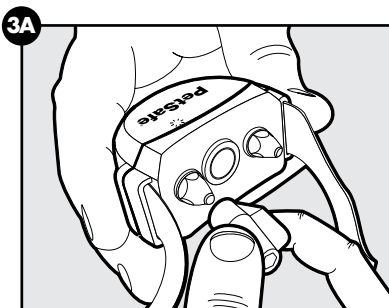

## Receiver Collar Status Indicators

The receiver collar status indicator light along with the receiver collar alarm tone are used to determine the battery status, and the correction type. Refer to the receiver collar status indicator table below to understand the status lights and tones for the receiver collar.

During normal operation, the receiver collar indicator light will flash every 4–5 seconds to indicate the battery status as shown in the table below.

<b>Receiver Collar Status Indicator Table</b>		
<b>Status Light</b>	<b>Alarm Tone</b>	<b>Condition</b>
<b>While Plugged into Receiver Charger</b>		
Solid red	No tone	Charge in progress
Solid green	No tone	Charge complete
No light		Charge failure, contact Customer Care Center
<b>After Removing from Receiver Charger</b>		
Continuous green or yellow or red (5 seconds duration)	No tone	Battery charge indication, occurs immediately after unplugging the charger from the receiver collar
<b>Operating Battery Status</b>		
Slow blinking green (every 4-5 seconds)	No tone	Collar battery charge 100%–60%
Slow blinking yellow (every 4-5 seconds)	No tone	Collar battery charge 60%–20%
Slow blinking red (every 4-5 seconds)	No tone	Collar battery charge 20% or less, charge immediately
<b>Receiver Activation Status</b>		
Fast pulsating green (3 flashes per second)	Warning tone	Warning tone
Fast pulsating red (3 flashes per second)	Tone for duration of static correction	Static correction being delivered up to 15 seconds
Continuous green (10 seconds)	No tone	Over correction protection; collar locked for 10 seconds

## Set the Static Correction Level

Read all steps before attempting to set the static correction level.

1. Press the mode button and release (**3B**) when the receiver indicator light illuminates red (**3C**).
2. The receiver indicator light will emit a series of red flashes representing the static correction level.
3. Increase the static correction level by pressing and releasing the mode button within 5 seconds of the previous series of flashes.

The static correction levels increase in strength from 1 to 6. Pushing the correction level button while the receiver collar is on level 6 will cause the receiver collar to revert to level 1. Refer to the function and response table to choose the static correction level that best fits your pet.

### Function and Response Table

Indicator Light Response	Static Correction Level	Receiver Collar Function
1 red flash	1	No static correction, Tone-only
2 red flashes	2	Low static correction
3 red flashes	3	Medium-low static correction
4 red flashes	4	Medium static correction
5 red flashes	5	Medium-high static correction
6 red flashes	6	High static correction

### Over Correction Protection

If your pet enters the boundary zone or continues anywhere beyond the pet area, this feature limits the static correction duration to 15 seconds. While the system locks out further static correction, the green light will remain on for 10 seconds.

In the unlikely event that your pet leaves the pet area, he will not receive a static correction upon return to the pet area.

## Step 4: Adjust the Pet Area to Desired Size

Make sure the entire pet area lies within your property boundaries (4A). Always start determining the boundary zone at the shortest distance from transmitter. Place the boundary switch on "Low" if the boundary zone will be less than 45 feet from the transmitter.

### Test Light Instructions

1. Make sure the receiver collar battery is properly charged.
  2. Set the correction level to 2 or above.
  3. Hold the test light contacts to the contact points. (4B)
  4. Walk toward the boundary zone holding the receiver collar about waist high until the test light flashes (4C).
- Save the test light for future testing.

**Note:** If your next-door neighbor has a containment system, see the troubleshooting section page 18.

To maximize your pet area, make sure the boundary switch is on "High" and the boundary control dial is set to "8". Plug the power adaptor into the power jack and a standard 120 volt outlet.

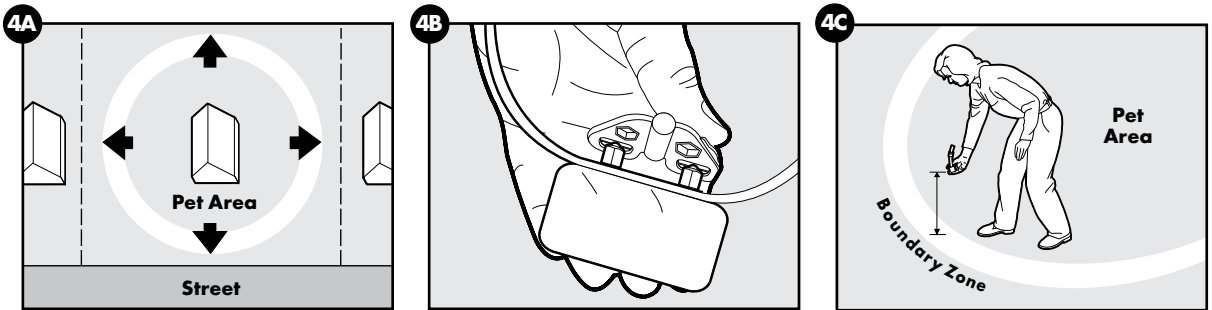

### Two-Person Method

Hold the receiver collar about waist high with logo side facing away from the transmitter and contact points facing upwards. Walk to the edge of the desired pet area. Facing away from the transmitter, hold the receiver collar at the edge of the desired pet area (4C).

Starting with the boundary control dial set to "8", have a second person turn the dial down SLOWLY. When the receiver collar tone starts, tell the person to stop turning the boundary control dial. Walk back into the pet area until the receiver stops sounding. Verify the pet area boundary by walking towards the boundary zone and verifying that the tone/test light flashes begin at the desired location. Test at multiple locations around the pet area to verify the pet area is within your desired location. Record your settings on page 13 for future reference.

### One-Person Method

Measure the shortest distance from the desired boundary zone to the transmitter. Find the distance on the transmitter range chart on page 13 and set the boundary switch and boundary control dial. Hold the test light contacts to the contact points (4B). Take the receiver collar to the boundary zone with the logo side facing away from the transmitter and contact points facing upwards (4C). Hold the receiver collar about waist high until the receiver collar tone sounds and the test light flashes. If the receiver collar tone sounds before or after the desired boundary zone, return to the transmitter and adjust the boundary control dial. Repeat this process until the receiver collar tone sounds at the desired location. Record your settings on page 13 for future reference.

## Transmitter Range Chart

Boundary Control Dial Position	Boundary Switch LOW	Boundary Switch HIGH
1	22 ft	46 ft
2	24 ft	50 ft
3	26 ft	56 ft
4	29 ft	62 ft
5	31 ft	69 ft
6	37 ft	85 ft
7	45 ft	95 ft
8	50 ft	105 ft

**Note:** These distances are approximate.

## Record Your Settings

Location	Final Boundary Switch Setting (HIGH or LOW)	Final Boundary Control Dial Position (1–8)	Receiver Static Correction Level (1–6)
Home			
Camping			
Vacation			
Other			

## Step 5: Place the Boundary Flags

The boundary flags are visual reminders for your pet of where the boundary zone is located. The receiver collar will activate within 2 to 3 feet of the boundary flags.

1. Using the test light, with the static correction level set at 2 or greater, hold the receiver collar at your pet's neck height with logo side facing away from the transmitter.
2. Walk towards the boundary zone until the receiver collar beeps and the test light flashes (**5A**).
3. Place a boundary flag in the ground (**5B**).
4. Walk back into the pet area until the beeping stops.
5. Repeat this process around the boundary zone until it is marked with boundary flags every 10 feet.

The boundary flags may be in different parts of the boundary zone and may not be in a line. The boundary zone is 2 to 3 feet wide.

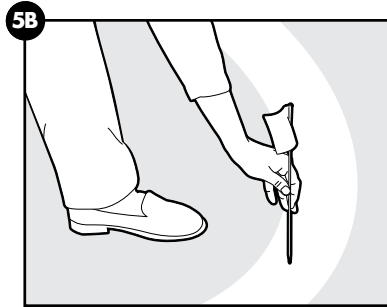
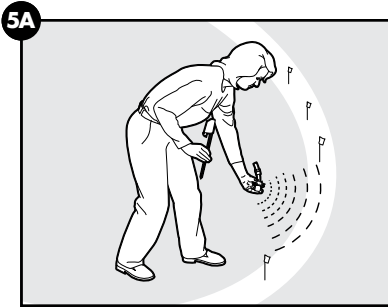

## Step 6: Fit the Receiver Collar

**Important: The proper fit and placement of your receiver collar is important for effective training. The contact points must have direct contact with your pet's skin on the underside of his neck.**

### CAUTION

Please read and follow the instructions in this manual. Proper fit of the collar is important. A collar worn for too long or made too tight on the pet's neck may cause skin damage ranging from redness to pressure ulcers; this condition is commonly known as bed sores.

- Avoid leaving the collar on the dog for more than 12 hours per day.
- When possible reposition the collar on the pet's neck every 1 to 2 hours.
- Check the fit to prevent excessive pressure; follow the instructions in this manual.
- Never connect a lead to the electronic collar; it will cause excessive pressure on the contacts.
- When using a separate collar for a lead, don't put pressure on the electronic collar.
- Wash the dog's neck area and the contacts of the collar weekly with a damp cloth.
- Examine the contact area daily for signs of a rash or a sore.
- If a rash or sore is found, discontinue use of the collar until the skin has healed.
- If the condition persists beyond 48 hours, see your veterinarian.
- For additional information on bed sores and pressure necrosis, please visit our website.

These steps will help keep your pet secure and comfortable. Millions of pets are comfortable while they wear stainless steel contacts. Some pets are sensitive to contact pressure. You may find after some time that your pet is very tolerant of the collar. If so, you may relax some of these precautions. It is important to continue daily checks of the contact area. If redness or sores are found, discontinue use until the skin has fully healed.

## To assure a proper fit, please follow these steps:

1. Make sure transmitter is not plugged in, and the receiver is turned off.
2. Start with your pet standing comfortably (6A).
3. To make it easier to hear the warning beep, place the receiver collar on your pet with the logo side of receiver facing your pet's chin.
4. Center the contact points underneath your pet's neck, touching the skin.

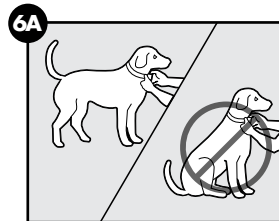

**CAUTION** You may need to trim the hair in the area of the contact points. Never shave the dog's neck; this may lead to a rash or infection.

5. Check the tightness of the receiver collar by inserting one finger between the end of a contact point and your pet's neck. The fit should be snug but not constricting (6B).
  - a. Allow your pet to wear the collar for several minutes then recheck the fit.
  - b. Check the fit again as your pet becomes more comfortable with the receiver collar.
6. Trim the collar as follows (6C):
  - a. Mark the desired length of the receiver collar with a pen. Allow for growth if your pet is young or grows a thick winter coat.
  - b. Remove the receiver collar from your pet and cut off the excess.
  - c. Before placing the receiver collar back onto your pet, seal the edge of the cut collar by applying a flame along the frayed edge.

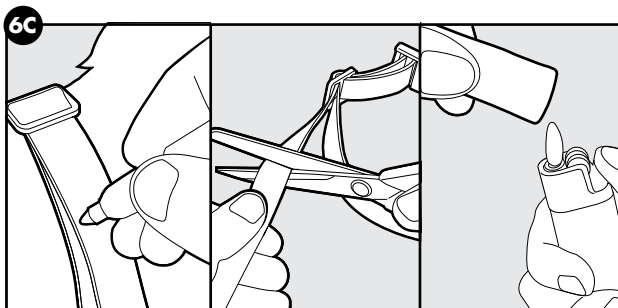

## Re-Thread the Collar

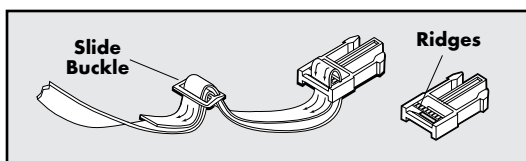

The slide buckle prevents the collar from becoming loose around your pet's neck. The ridges must be facing up; the collar will slip if it is not properly threaded.

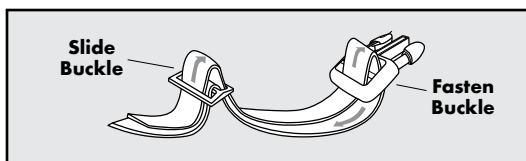

**To loosen:** Slide the strap through the slide buckle and fasten buckles and pull down.

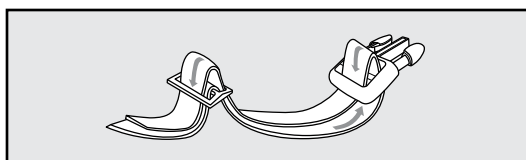

**To tighten:** Slide the strap up through the fasten buckle and pull through the slide buckle.

# Training

- Remember that this system is not a solid barrier. Using it successfully requires that you spend some time training your pet.
- Finish each training session on a positive note with lots of praise and play. Remove the collar after each training session.
- While your pet is still learning the boundary, contain him by another means, such as with a pen or a leash.
- Put a separate non-metallic collar on your pet's neck and attach a leash.
- Be sure to place the collar on your dog's neck with the PetSafe® logo facing up.
- If your pet appears to be stressed, slow down the training schedule, add additional days of training or increase the amount of play time. Common stress signals include pulling on the leash toward the house, ears tucked or pulled back, tail down or tucked between legs, body lowered, nervous/frantic movement or stiffening of the pet's body, lip-licking or yawning.

## Day 1

For the first day, start with the collar set to level 1, tone-only. With your pet on a leash and with his favorite treats on hand, allow him to explore the pet area (7A). Allow your pet to cross the boundary (7B) and hear the tone from the collar, then ask him to come back into the pet area (7C) and praise and reward him. Your goal is for your dog to associate being inside the pet area with rewarding experiences. Dogs are sensitive. Keep your mood upbeat as dogs can understand when you are happy or upset. Do two or three training sessions for about 10-15 minutes each. Do not try to do too much too quickly. More frequent short sessions are better than less frequent, longer sessions.

## Days 2-4

On days 2 through 4, repeat this process, but with the collar set to level 2—the mildest static correction level. Closely observe your pet's behavior while he is in the boundary zone (7B), and note whether or not your dog responds to the correction. Indicators of a response include: looking around in curiosity, flicking of the ears or scratching at the collar. If he does not respond, check the fit of the collar to make sure the contact points are making contact with his skin. If the collar is fit correctly and your dog does not respond, then move up to the next correction level and repeat the process. Do two or three training sessions for about 10-15 minutes each. Your goal is for your dog to consistently choose to stay in the pet area. If necessary, add in more days of training before moving on to the next step.

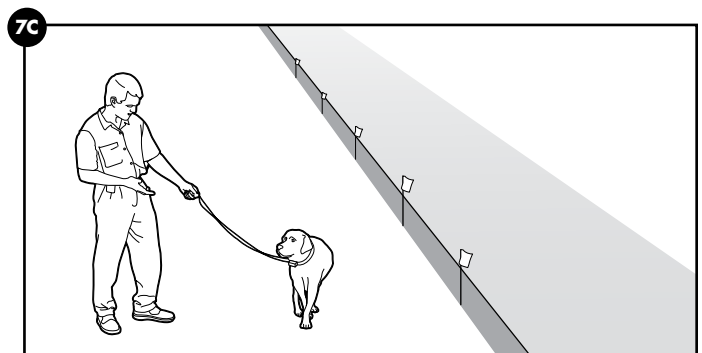
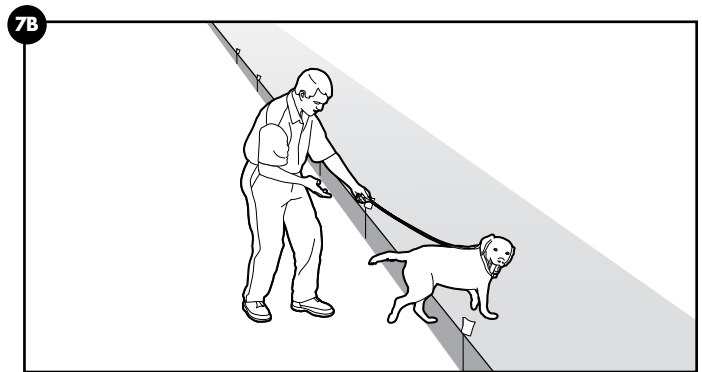
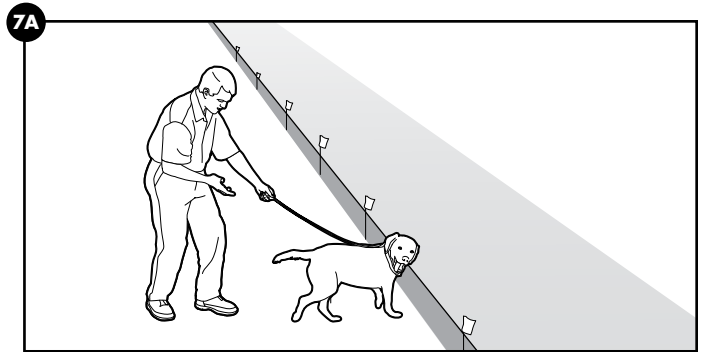



## Days 5–8

On days 5 through 8, retain the collar settings from the last training session, but stage some distractions to test your dog's reliability. The goal is to have your pet stay within the boundary even with new temptations. Start with simple temptations and work your way up. Some examples are:

- Have a family member cross from inside the boundary and exit it.
- Place a toy outside the boundary.
- Have a friend or neighbor walk another pet outside the boundary area.

Remember to keep your pet on a leash throughout this process while he is still learning the boundary. Also, never coax your pet to leave the pet area.

**CAUTION** Be sure the extra collar does not put pressure on the contact points.

## Days 9–30

Once your pet consistently respects the boundary zone regardless of distractions or temptations, he is ready for the next step: unleashed supervision (**7D**). Stay close by with a leash at hand. Play with your pet for a while during the first few sessions. If your dog does not try to cross the boundary zone, occupy yourself with another task in the yard, and allow him to freely explore.

Continue watching your pet. If he escapes, remove the collar and lead him back into the pet area. Start these sessions at about 15 minutes and gradually work up to an hour or more.

When your pet proves trustworthy, you can let him out on his own. Continue to check on him regularly. You can remove every other boundary flag every 4 days until all the flags are removed. Save them in case you move or need to train another pet.

## Taking Your Pet Out of the Pet Area

**Important:** Remove the receiver collar and leave it at home.

Once your pet learns the boundary zone, he will be reluctant to cross it for walks or car rides.

### Option 1:

Replace the receiver collar with a regular collar. Put your pet in a car that is within the pet area and drive him out of the pet area (**7E**).

### Option 2:

Replace the receiver collar with a regular collar and leash. Walk your pet out of the pet area while giving a command such as "OK" at a specific place along the boundary zone (the end of your driveway, sidewalk, etc.). Always leave the pet area from the same spot in your yard with a leash and your pet will associate leaving the pet area only on a leash, only at this spot, and only with a person. You may initially need to convince your pet to leave the pet area with a treat and lots of praise.

**Note:** You may also carry your pet out of the pet area.

**Congratulations!** You have now completed the training program. You are both ready to enjoy more freedom. Just make sure to continue to check the tightness of the receiver collar and remove it when it is not in use.

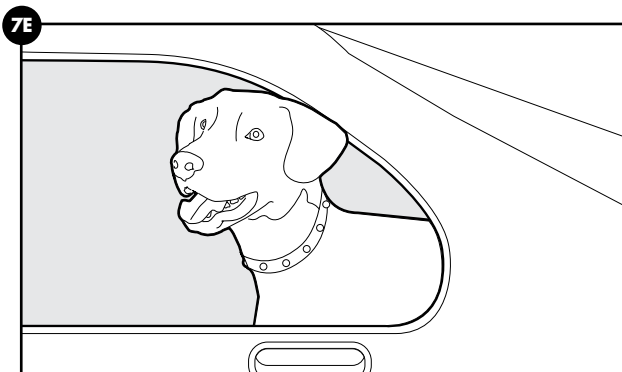
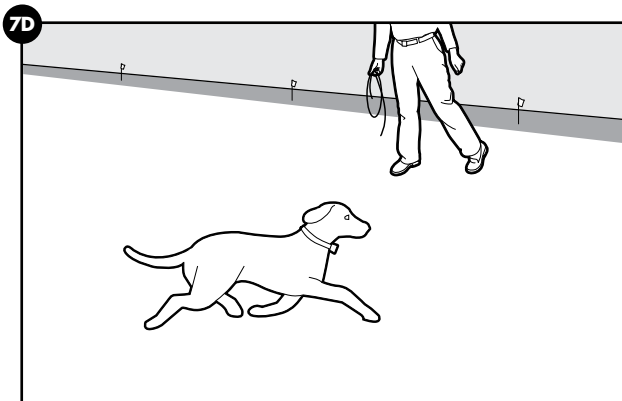

## Wireless-to-Go

Your PetSafe® Stay & Play™ Compact Wireless Fence system is completely portable. Follow the setup procedures (Steps 1 through 4) wherever you wish to have containment of your pet. Reestablish the pet area and mark it with boundary flags so your pet knows his boundary zone. Place the transmitter indoors at least 3 feet from large metal objects.

**Note:** If setting up in a metal building or vehicle, the maximum size of the pet area may be reduced. Be sure to remove the receiver collar before removing power from the transmitter. If you want to power the transmitter from a car or other DC source, use an inverter rated for 50 watts or more.

## Troubleshooting

<p><b>The transmitter is sounding an intermittent double tone alarm.</b></p>	<ul style="list-style-type: none"> <li>The intermittent double tone is the metal interference alarm. This alarm sounds if the transmitter is placed too close to a metal surface. When this alarm sounds, the transmission output is disabled and your pet is no longer being contained. Relocate the transmitter and either unplug the power adaptor from the power jack or press the alarm disable button for 5 seconds then release.</li> </ul>
<p><b>The transmitter is sounding a intermittent single tone when I unplug the power adaptor from the wall outlet.</b></p>	<ul style="list-style-type: none"> <li>The power loss alarm in the transmitter is activated to alert you that power has been removed from the transmitter and your pet is no longer being contained. To turn off the power loss alarm, unplug the power adaptor from the power jack located on the bottom of the transmitter or press the alarm disable button for 5 seconds then release.</li> </ul>
<p><b>The transmitter is generating a loud continuous tone.</b></p>	<ul style="list-style-type: none"> <li>The transmitter has a built in transmission failure alarm that continuously monitors the transmitter output. If a transmission failure ever occurs the alarm warns you that your pet is no longer being contained. Contact the Customer Care Center for a replacement transmitter.</li> </ul>
<p><b>The receiver collar tone is not sounding when setting up the boundary zone.</b></p>	<ul style="list-style-type: none"> <li>Make sure the receiver collar is turned on and battery status lights are flashing every 4-5 seconds.</li> <li>Charge receiver collar.</li> <li>The tone may be difficult to hear in a noisy environment.</li> <li>Use test light as explained in the "test light instructions" section, and use it to determine the location of boundary zone.</li> <li>Check that the transmitter is set up according to directions.</li> </ul>
<p><b>The receiver collar tone is not sounding or administering a static correction.</b></p>	<ul style="list-style-type: none"> <li>Make sure receiver collar is turned on and battery status lights are flashing every 4-5 seconds.</li> <li>Charge receiver collar.</li> <li>Check that the transmitter is plugged into a working 120 volt outlet, the power light is on, and the transmitter controls are set at your desired settings.</li> </ul>
<p><b>The receiver collar tone is sounding everywhere.</b></p>	<ul style="list-style-type: none"> <li>Check that the transmitter is plugged into a working standard 120 volt outlet, the power light is on, and the transmitter controls are set at your desired settings.</li> <li>Bring the receiver collar within 10 feet of the transmitter to reset.</li> <li>Make sure no continuous alarm is sounding on the transmitter.</li> </ul>

# Troubleshooting

<p><b>The receiver collar tone is sounding inside the house.</b></p>	<ul style="list-style-type: none"> <li>• It is recommended to remove the receiver collar from your pet when indoors to avoid activation of the receiver collar.</li> <li>• Make sure the transmitter is on and set up according to the directions.</li> <li>• Ensure the entire house is within the pet area. The transmitter may need to be moved to adjust the pet area to include the entire house.</li> <li>• If relocating the transmitter, remove the receiver collar from your pet before turning the transmitter off.</li> </ul>
<p><b>My pet is receiving a static correction in his metal crate.</b></p>	<ul style="list-style-type: none"> <li>• The receiver collar activates when it loses the transmitter signal. The metal crate may block the transmitter signal which causes the receiver collar to activate.</li> <li>• Remove the receiver collar from your pet when placing him in his metal crate.</li> </ul>
<p><b>The boundary zone seems to fluctuate.</b></p>	<ul style="list-style-type: none"> <li>• This is normal for the electromagnetic field of the Stay &amp; Play™ Compact Wireless Fence transmitter. The field may be affected by surrounding "electronic noise," which can cause it to fluctuate up to 5%.</li> <li>• Where the receiver collar activates is influenced by the speed and orientation of the receiver collar as your pet enters the boundary zone.</li> </ul>
<p><b>The receiver collar activates in the middle of the yard.</b></p>	<ul style="list-style-type: none"> <li>• The receiver collar activates when it loses the transmitter signal. This sometimes occurs if a large metal object is between the receiver collar and transmitter, if the orientation of the receiver collar changes near the boundary zone, or if the surrounding "electronic noise" interferes with the signal. If this continues to occur, consider relocating the transmitter and resetting the pet area.</li> </ul>
<p><b>The receiver collar tone is sounding but my pet is not responding to the static correction.</b></p>	<ul style="list-style-type: none"> <li>• Make sure the static correction level is set at 2 or above.</li> <li>• Test the receiver collar with the test light.</li> <li>• If the test light flashes, check the fit of the receiver collar.</li> <li>• Trim your pet's fur where the contact points touch the neck and/or switch to the longer contact points.</li> <li>• Increase the static correction level.</li> <li>• Repeat training steps to reinforce training.</li> </ul>
<p><b>My pet reacts strongly to the static correction and has become fearful.</b></p>	<ul style="list-style-type: none"> <li>• Lower the static correction level.</li> <li>• Make sure you are in control of the situation when your pet receives his first static corrections (have him on a leash attached to a separate, non-metallic collar) and lead him into the pet area and praise him. If your pet remains fearful, suspend training and start again the next day. Make sure to end all training sessions on a positive note with lots of praise and play.</li> </ul>
<p><b>The transmitter power light is not on.</b></p>	<ul style="list-style-type: none"> <li>• Make sure the power adaptor is plugged into a working 120 volt wall outlet.</li> <li>• Verify that the outlet is working properly by plugging in a known working item such as a lamp.</li> <li>• If the power light still does not come on, the fence transmitter and/or power adaptor needs to be replaced. Contact the Customer Care Center.</li> </ul>

## Troubleshooting

<p><b>I was setting up the pet area and after I turned down the boundary control dial, the receiver collar would no longer beep or correct.</b></p>	<ul style="list-style-type: none"><li>• You may have turned the boundary control dial down too quickly, causing the receiver collar to go into power-fail mode. This is a safety feature designed to protect your pet when power to the transmitter goes out. With the receiver collar within 10 feet of the transmitter, readjust the boundary control dial as shown in Step 4 and reset the boundary zone, making sure to turn the dial down slowly.</li></ul>
<p><b>My next-door neighbor has a containment system and the receiver collar does not activate near their property.</b></p>	<ul style="list-style-type: none"><li>• Your neighbor's containment signal may interfere with the operation of the receiver collar preventing activation close to their fence. To minimize the interference, reduce the size of the pet area or move the transmitter away from your neighbor's system.</li><li>• Adjust the pet area so that the receiver collar activates for at least 5 feet beyond the reduced boundary setting when walking towards the neighboring containment system.</li></ul>
<p><b>The receiver collar has injured my pet's neck.</b></p>	<ul style="list-style-type: none"><li>• Failing to follow the important safety information at the front of the product manual has caused pressure ulcers. Some descriptions of advanced pressure ulcers describe the sores as looking like burns on the dog's neck. Be assured that electronic collars do not use enough energy to create electrical burns. The energy in an output pulse is only a few thousandths of a Joule; it is similar in nature to the static pulse that you may feel when getting out of your car. In some cases, pressure ulcers are described as chemical burns. The battery in your receiver collar is sealed, in addition, your collar's housing is also sealed. This sealing makes it virtually impossible, without misuse or abuse, for your receiver collar battery to leak onto your pet's neck. Please review and follow the important safety information on page 3, and the instructions in Step 6 under the heading "Fit the receiver collar" on page 14.</li></ul>

# Terms of Use and Limitation of Liability

## 1. Terms of Use

The use of this product is subject to your acceptance without modification of the terms, conditions and notices contained with this product. Use of this product implies acceptance of all such terms, conditions, and notices. If you do not wish to accept these terms, conditions, and notices, please return the product, unused, in its original packaging and at your own cost and risk to the relevant Customer Care location together with proof of purchase for a full refund.

## 2. Proper Use

Proper Use includes, without limitation, reviewing the entire Product Manual and any specific safety information statements. The specific temperament or size/weight of your pet may not be suitable for this product. If you are unsure whether this product is appropriate for your pet, please consult your veterinarian or certified trainer prior to use. For products used with pets where training is desired, Radio Systems Corporation recommends that these training products are not used if your pet is aggressive and accepts no liability for determining suitability in individual cases.

## 3. No Unlawful or Prohibited Use

This product is designed for use with pets only. This product is not intended to harm, injure or provoke. Using this product in a way that is not intended could result in violation of Federal, State or local laws.

## 4. Limitation of Liability

In no event shall Radio Systems Corporation or any of its associated companies be liable for (i) any direct, indirect, punitive, incidental, special or consequential damage and/or (ii) any loss or damages whatsoever arising out of or connected with the use or misuse of this product. The Purchaser assumes all risks and liability from the use of this product to the fullest extent permissible by law.

## 5. Modification of Terms and Conditions

Radio Systems Corporation reserves the right to change the terms, conditions and notices governing this product from time to time. If such changes have been notified to you prior to your use of this product, they shall be binding on you as if incorporated

# Compliance

## FCC/IC

This Class B digital apparatus complies with Canadian RSS-310. This equipment has been tested and found to comply with the limits for a Class B digital device, pursuant to Part 15 of the FCC Rules. These limits are designed to provide reasonable protection against harmful interference when the equipment is operated in a residential environment. This equipment generates, uses, and can radiate radio frequency energy and, if not installed and used in accordance with the instruction guide, may cause harmful interference to radio communications. However, there is no guarantee that interference will not occur in a practical installation. If this equipment causes harmful interference to radio or television reception, which can be determined by turning the equipment off and on, the user is encouraged to try to correct the interference by one or more of the following measures:

- Relocate the interfered receiving antenna.
- Increase the separation between the equipment and receiver.
- Connect the equipment into an outlet on a circuit different to that to which the receiver is connected.
- Contact the Customer Care Center at +1 (800) 732-2677.

This device complies with Industry Canada Rules. This device complies with part 15 of the FCC Rules. Operation is subject to the following two conditions: (1) This device may not cause harmful interference, and (2) this device must accept any interference received, including interference that may cause undesired operation.

Unauthorized changes or modifications to the equipment, not approved by Radio Systems Corporation, could result in not meeting compliance with FCC regulations and could void the user's authority to operate the equipment.

## ACMA/Australia

This device complies with the applicable EMC requirements specified by the ACMA (Australian Communications and Media Authority).

---

## Customer Care International

### USA & Canada—Tel: 800-732-2677

Monday–Friday 8 AM – 8 PM / Saturday 9 AM – 5 PM

### Australia—Tel: 1800 786 608

Monday–Friday 8:30 AM – 5 PM

### New Zealand—Tel: 0800 543 054

Monday–Friday 10:30 AM – 7 PM

---



## Important Recycling Advice

Please respect the Waste Electrical and Electronic Equipment regulations in your country. This equipment must be recycled. At the end of the product life, do not place it in the normal municipal waste system. Please check the regulations in your area or return it to where it was purchased so that it can be placed in our recycling system. If these options are not possible, please contact the Customer Care Center for further information.

---

## Warranty

### One Year Non-Transferable Limited Warranty

This Product has the benefit of a limited manufacturer's warranty. Complete details of the warranty applicable to this Product and its terms can be found at [www.petsafe.com](http://www.petsafe.com) and/or are available by contacting your local Customer Care Center.

## **United States and Canada**

Radio Systems Corporation  
10427 PetSafe Way  
Knoxville, TN 37932 USA

**Australia/New Zealand**—In compliance with the Australian Consumer Law, Warranties Against Defects, effective January 1, 2012, warranty details of this Product are as follows:

### **One Year Non-Transferable Limited Warranty**

What is covered: Radio Systems Australia Pty Ltd. (hereinafter referred to as “Radio Systems”) warrants to the original retail purchaser, and not any other purchaser or subsequent owner, that its product, when subject to normal and proper residential use, will be free from defects in material or workmanship for a period of one (1) year from the purchase date. An “original retail consumer purchaser” is a person or entity who originally purchases the Product, or a gift recipient of a new product that is unopened and in its original packaging. When serviced by Radio Systems Customer Service, Radio Systems covers labour and parts for the first year of ownership; after the first year, a service or upgrade charge will apply relative to replacement of the product with new or refurbished items at Radio Systems’ sole discretion.

The limited warranty is non-transferable and shall automatically terminate if the original retail consumer purchaser resells the Radio Systems product or transfers the property on which the Radio Systems product is installed. This Limited Warranty excludes accidental damage due to dog chews; lightning damage; or neglect, alteration, and misuse. Consumers who purchase products outside of Australia, New Zealand, or from an unauthorised dealer will need to return the Product to the original place of purchase for any warranty issues.

Please note that Radio Systems does not provide refunds, replacements, or upgrades for change of mind, or for any other reason outside of these Warranty terms.

Claims Procedure: Any claim made under this Warranty should be made directly to Radio Systems Australia Pty Ltd. Customer Care Centre at:

Radio Systems Australia Pty Ltd.  
PO Box 3442  
Australia Fair QLD 4215, Australia  
  
Australia Residents: 1800 786 608  
New Zealand Residents: 0800 543 054  
Email: [aus-info@petsafe.net](mailto:aus-info@petsafe.net)

To file a claim, a proof of purchase must be provided. Without a proof of purchase, Radio Systems will not repair or replace faulty components. Radio Systems requests the Consumer to contact the Radio Systems Customer Care Centre to obtain a Warranty Return number, prior to sending the Product. Failure to do so may delay in the repair or replacement of the Product.

If the Product is deemed to be faulty within 30 days from date of original purchase, Radio Systems will organise for a replacement to be sent in advance of returning the faulty Product. A Post Bag will be included with the replacement Product for the return of the faulty Product. The Product must be returned within 7 days of receiving the replacement. If the Product is deemed to be faulty after 30 days from the date of original purchase, the consumer will be required to return the Product to Radio Systems at the consumer’s own expense. Radio Systems will test and replace the faulty unit or its components and return to the consumer free of charge, provided the Product is within its said warranty period. This warranty is in addition to other rights and remedies available to you under the law. Radio Systems goods come with guarantees that cannot be excluded under the Australia Consumer Law. You are entitled to a replacement or refund for a major failure and for compensation for any other reasonably foreseeable loss or damage. You are also entitled to have the goods repaired or replaced if the goods fail to be of acceptable quality and the failure does not amount to a major failure.

Should you have any queries or require any further information, please contact our Customer Care Centre on 1800 786 608 (Australia) or 0800 543 054 (New Zealand).



## Mounting Template

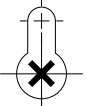

2 1/2 INCHES (63.5mm)

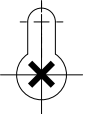

Radio Systems Corporation  
10427 PetSafe Way  
Knoxville, TN 37932  
+1 (800) 732-2677  
petsafe.com

For a list of patents protecting this product, please visit  
[www.radiosystemscorporation.com/patents](http://www.radiosystemscorporation.com/patents)

YU400-1243/6

©2019 Radio Systems Corporation